

FORM 18034  
September, 1935  
PRINTED IN U. S. A.

HISTORICAL COPY  
DO NOT REMOVE

# LIST OF PARTS



**MACHINE No. 55-20**

---

\*\* A TRADE MARK OF  
**THE SINGER MANUFACTURING COMPANY**

From the library of: Diamond Needle Corp

# INSTRUCTIONS FOR OILING

---

To ensure easy running and prevent unnecessary wear of the parts which are in movable contact, the machine requires oiling and when in continuous use, "TYPE B" or "TYPE D" OIL, sold only by Singer Sewing Machine Company, should be applied at least twice each day to all oil holes marked "OIL", as instructed in Form 19726.

"TYPE D" OIL is stainless.

Occasionally check the grease in gear case on the underside of the bed of the machine and fill gear case, when necessary, with GEAR LUBRICANT, sold only by Singer Sewing Machine Company.

Copyright, U. S. A., 1921, 1933 and 1935,  
by The Singer Manufacturing Co.  
All Rights Reserved for all Countries

## INDEX

---

	Page
Accessories.....	12
Finger Guard.....	12
Foot Lifter Parts.....	12
Knee Lifter Parts.....	13
Machine No. 55-20.....	5
Numerical List of Parts.....	17
Thread Unwinder.....	14

From the library of: Diamond Needle Corp

INSTRUCTIONS FOR ORDERING

In ordering from this list, use ONLY the part NUMBER in the FIRST column.

The number stamped on a Sewing Machine Part is in every case the number of the single part only.

Every combination of parts sent out as such has its specific number, which, although not stamped on the parts, must be used when ordering the combination.

Each number always indicates the SAME PART in whatever list it appears, or for whatever machine.

The letters after some of the numbers indicate the style of finish only, as follows:

- A-Hardened, Polished, Nickel Plated and Buffed
- B-Polished, Nickel Plated and Buffed
- C-Hardened Only
- D-Polished Only
- E-Soft, Not Polished
- F-Hardened and Polished
- H-Blued
- J-Nickel Plated Only
- K-Hardened and Nickel Plated
- L-Brass Plated
- M-Oxidized
- N-Japanned, Dull
- P-Japanned, Bright
- R-Merlized
- T-Copper Plated
- T.A-Hardened, Polished, Copper and Nickel Plated and Buffed
- T.B-Copper and Nickel Plated and Polished
- T.J-Copper and Nickel Plated Only
- T.K-Hardened, Copper and Nickel Plated
- T.M-Copper Plated and Oxidized
- T.L-Copper and Brass Plated
- U-Zinc Plated
- V-Silver Plated
- W-Polished and Nickel Plated
- Y-Black Nickel Plated Only
- Z-Chromium Plated
- Z.B-Polished, Nickel Plated, Buffed and Chromium Plated
- Z.J-Nickel and Chromium Plated

These letters MUST BE USED when they appear in the list; and AFTER the number as in the list.

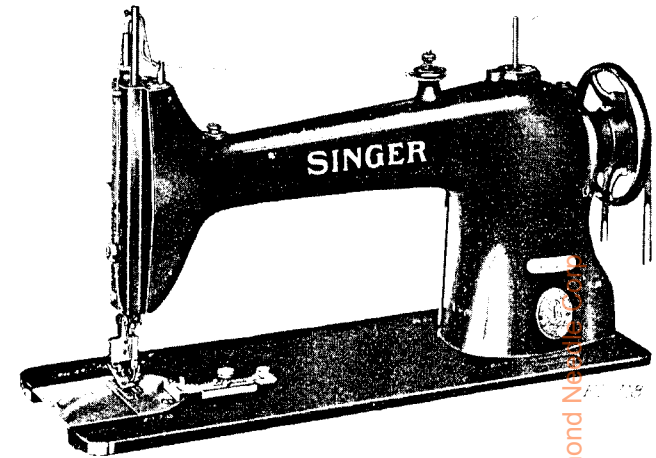
In this series:

- 1 to 1500, 50001 to 51500 and 140001 to 142000 are Screw Numbers
- 1501 to 1800 and 51501 to 51800 are Nut Numbers
- 1801 to 2000 and 51801 to 52000 are Roller Numbers
- 2001 to 50000 and 52001 to 140001 and 142000 to 190000 are Sewing Machine Parts, 190001 and upward are numbers of Electrical Parts

The figures in the second column refer only to the plates, illustrating the parts, and are NOT TO BE USED in ordering.

Parts marked with an asterisk (\*) are furnished only when repairs are made at factory.

LIST OF PARTS COMPLETE FOR



MACHINE NO. 55-20

FOR BASTING CLOTHING, ETC. ONE NEEDLE, ONE LOOPER, SINGLE THREAD CHAIN-STITCH FROM 1/4 TO 1/2 INCH LONG. ROTATING LOOPER DRIVEN BY GEARS MAKING ONE REVOLUTION AT EACH FULL STROKE OF THE NEEDLE BAR. THIS MACHINE WILL STITCH MATERIAL UP TO 3/8 INCH IN THICKNESS. SPEED 3000 R.P.M. ACCORDING TO THE MATERIAL BEING STITCHED.

No.	Plate	Name
*20929	-----	Arm with 15404 and two 15405.....
8582	5245	" Dowel Pin.....
68350	5245	" Oil Cup for oiling 52195.....
52084	5245	" " Tube with 52045, for oiling 24040
56015	5245	" " " for oiling 20932 and 52492..
52148	5245	" " " " 52149.....
52149	-----	" " " 52148 with 52150, for oiling 59703.....
52150	5245	Arm Oil Tube Oil Pad (braided cotton) for 52149.....
52045	5245	Arm Oil Tube Packing (wick) for 52084....
748E	5245	" Screw (back).....
854E	5245	" " (front).....
20930	22160	" Shaft (horizontal).....
20979	-----	" " " 20930 and 20960 and 20980.....

From the Dept. of Diamond Needle

## PARTS FOR MACHINE 55-20

No.	Plate	Name
52191	5246	Arm Shaft (horizontal) Flanged Bushing (back).....
52192	-----	Arm Shaft (horizontal) Flanged Bushing (back) 52191 with 52193 and 52194.....
52193	5245	Arm Shaft (horizontal) Flanged Bushing (back) Oil Pad, inside (braided cotton)
52194	5245	Arm Shaft (horizontal) Flanged Bushing (back) Oil Pad, outside (felt).....
448C	5247	Arm Shaft (horizontal) Flanged Bushing (back) Set Screw.....
52195	5246	Arm Shaft (horizontal) Flanged Bushing (front).....
52196	-----	Arm Shaft (horizontal) Flanged Bushing (front) 52195 with 52193 and 52198.....
52193	5245	Arm Shaft (horizontal) Flanged Bushing (front) Oil Pad, inside (braided cotton)
52198	5245	Arm Shaft (horizontal) Flanged Bushing (front) Oil Pad, outside (felt).....
435C	5247	Arm Shaft (horizontal) Flanged Bushing (front) Set Screw.....
59703	5247	Arm Shaft (horizontal) Gear with two 1036C
1036C	5247	" " " " Set Screw.....
144D	5247	" " " " Screw.....
20931	5246	" " (upright).....
52492	5247	" " " Bushing (lower).....
432C	5247	" " " " " Set Screw.....
20932	5247	Arm Shaft (upright) Bushing (upper).....
1149C	5247	" " " " " Set Screw.....
127073	5247	Arm Shaft (upright) Gear (lower) with two 1259C.....
1259C	5247	Arm Shaft (upright) Gear (lower) Set Screw
59708	5247	" " " " (upper) with two 1253C.....
1253C	5247	Arm Shaft (upright) Gear (upper) Set Screw
12480	5246	" Side Cap.....
219J	5247	" " " Screw.....
12193	5246	" " Cover.....
51224D	5247	" " " Thumb Screw.....
12403	5247	" Spool Pin and Thread Eyelet.....
20973	-----	" Top Cover.....
20933	5246	" " " 20973 with 12403 and two 20934.....
20934	5245	Arm Top Cover Oil Tube with 56006, for oiling 20981 and 20946.....
56006	5245	Arm Top Cover Oil Tube Packing (braided cotton).....

## PARTS FOR MACHINE 55-20

No.	Plate	Name
158E	5247	Arm Top Cover Screw.....
52005	5246	Balance Wheel (power) light rim, 2 3/16 in. pulley, with two 448C.....
52063	5246	Balance Wheel Oil Cover.....
210J	5247	" " " " Screw.....
448C	5247	" " " Set Screw.....
*20935	-----	Bed.....
20936	-----	" Slide.....
20937	5248	" " 20936 with 5947 and two 725J....
5947	5248	" " Spring.....
725J	5247	" " " Screw.....
20938	5248	Face Plate with 20940 and two 2827.....
20939	-----	Face Plate complete, Nos. 208J, 9544, 9545, 20938 and two 9543.....
190J	5247	Face Plate Screw.....
20940	5247	" " " Thread Eyelet.....
2827	5247	" " " Guard with 8505.....
8505	5247	" " " " Rivet.....
9543	5247	" " " " Nipper Disc.....
9544	5247	" " " " " Cover.....
208J	5247	" " " " " " Screw.....
9545	5247	" " " " " " Spring.....
20941	22151	Feed Bar.....
313C	5249	" " " " " Screw Center.....
56813	-----	" " " " " 313C with 1519J....
1519J	5249	" " " " " Nut.....
20942	5248	" " " " " Cam and Feed Lifting Eccentric with two 448C.....
448C	5247	Feed Cam and Feed Lifting Eccentric Set Screw.....
20981	5248	Feed Connecting Rod with 896C and two 145E
20983	-----	" " " " " 20981 with 1714E, 20952 42523 and 51335C.....
145E	5249	Feed Connecting Rod Cap Screw.....
51335C	5249	" " " " " Hinge Screw.....
896C	5249	" " " " " " Clamping Screw.....
1714E	5249	Feed Connecting Rod Hinge Screw Nut.....
42523	5247	" " " " " " Washer
20945	22154	" " " " " Dog, 17 teeth (12 teeth to the inch) for 20968.....

Note: No. 20945 Feed Dog is sent with this Machine unless another Feed Dog is specified on order.

20974	22154	Feed Dog, 17 teeth (12 teeth to the inch) for 1/4 in. stitch for 20975, for Basting Coat Lapels.....
211E	5247	Feed Dog Screw.....

From the library of: Diamond Needle Corp

## PARTS FOR MACHINE 55-20

No.	Plate	Name
20946	5248	Feed Lifting Forked Connection with 20947 and two 1057E.....
20980	-----	Feed Lifting Forked Connection 20946 with 20942 and 20983.....
20947	-----	Feed Lifting Forked Connection Cap.....
1057E	5249	" " " " " Screw..
375C	5249	" " " " " Hinge Screw
1518E	5249	" " " " " " "
		Nut.....
52384	22151	Feed Lifting Rock Shaft.....
20948	-----	Feed Lifting Rock Shaft complete, Nos. 20950 and 52384.....
20949	5248	Feed Lifting Rock Shaft Crank with 157J...
20950	-----	Feed Lifting Rock Shaft Crank complete, Nos. 1519J, 20949 and 20978.....
157J	5249	Feed Lifting Rock Shaft Crank Clamping Screw.....
15170	5249	Feed Lifting Rock Shaft Crank Slide Block.
20978	-----	Feed Lifting Rock Shaft Crank Slide Block complete, Nos. 226J, 12424, 15170 and 51372C.....
226J	22152	Feed Lifting Rock Shaft Crank Slide Block Cap Screw.....
12424	5249	Feed Lifting Rock Shaft Crank Slide Block Cap Screw Washer.....
51372C	5249	Feed Lifting Rock Shaft Crank Slide Block Screw Stud.....
1519J	5249	Feed Lifting Rock Shaft Crank Slide Block Screw Stud Nut.....
50191C	5249	Feed Lifting Rock Shaft Screw Center.....
52097	-----	" " " " " " 50191C with 1513J.....
1513J	5249	Feed Lifting Rock Shaft Screw Center Nut..
52386	22151	" Rock Shaft.....
20970	-----	Feed Rock Shaft complete, Nos. 20951 and 52386.....
20951	5248	Feed Rock Shaft Regulator Crank with 790C and two 1147C.....
790C	5249	Feed Rock Shaft Regulator Crank Position Screw.....
1147C	5249	Feed Rock Shaft Regulator Crank Set Screw.
20952	5249	" " " " " Slide Block.....
50191C	5249	Feed Rock Shaft Screw Center.....
52097	-----	" " " " " 50191C with 1513J.....
1513J	5249	Feed Rock Shaft Screw Center Nut.....
28971	22151	Guide.....

## PARTS FOR MACHINE 55-20

No.	Plate	Name
28972	22151	Guide Holder.....
35610	5249	" " Friction Washer.....
940D	22152	" " Hinge Screw.....
120427	22151	" " Shank.....
20976	5249	" Leveling Plate.....
51224D	5247	" Thumb Screw.....
7071	5249	" " Washer.....
120428	22151	Guide (adjustable hinged) complete, Nos. 940D, 7071, 28971, 28972, 35610, 51224D and 120427.....
176J	5249	Guide Adjusting Screw.....
7071	5249	" " " Washer.....
184E	5249	" Screw Stud.....
20953	5249	Looper.....
20954	5249	" Driving Shaft.....
127004	22151	" " " Bushing.....
127043	-----	" " " " 127004 with 52045.....
52045	5245	Looper Driving Shaft Bushing Packing (wick).....
1143C	5249	Looper Driving Shaft Bushing Set Screw...
127073	5247	" " " Gear with two 1259C..
127007	22159	" " " " Case (two pieces) with 121E and 50234E.....
50234E	22152	Looper Driving Shaft Gear Case Plug Screw.
121E	22152	" " " " " Screw.....
1259C	5247	" " " " " Set Screw.....
1120C	5249	" Set Screw.....
20955	22155	" Shaft with 1120C and 20956.....
127005	22151	" " Bushing.....
127044	-----	" " " 127005 with 52045....
52045	5245	" " " Packing (wick).....
1148C	22152	" " " Set Screw.....
*20956	5249	" " Collar.....
124765	22151	" " Coupling with four 50150C....
50150C	22152	" " " Set Screw.....
20957	22155	Needle Bar (hollow) with 957H and 9611....
130768	22152	" " Bushing (lower).....
1133E	22152	" " " Set Screw.....
20958	22152	" " " (upper).....
1133E	22152	" " " Set Screw.....
24040	22159	" " Connecting Link with 794E.....
20971	-----	" " " " 24040 with 20959 and 24041.....
794E	22152	Needle Bar Connecting Link Adjusting Screw
20959	22152	" " " " Hinge Stud.....
1258C	22152	" " " " " Set Screw.....

## PARTS FOR MACHINE 55-20

No.	Plate	Name
24041	22152	Needle Bar Connecting Stud with 207E.....
207E	22152	" " " " Clamping Screw.
20960	22159	" " Crank with 858C, 1065C and 1258C
1065C	22152	" " " Position Screw.....
858C	22152	" " " Set Screw.....
124794	22152	" " Thread Retainer.....
20961	-----	Needle Bar Thread Retainer complete, Nos. 1449C, 20962, 54716 and 124794.....
20962	22152	Needle Bar Thread Retainer Bracket with 853C and two 42639.....
853C	22152	Needle Bar Thread Retainer Bracket Set Screw.....
42639	22152	Needle Bar Thread Retainer Position Pin...
1449C	22152	" " " " Screw.....
54716	22156	" " " " Spring.....
9611	22152	" " " Tube.....
857H	22152	" Set Screw.....
20963	22155	Presser Bar.....
5990	22152	" " Lifter.....
689C	22152	" " " Screw.....
1520E	22156	" " " Nut.....
11167	22155	" " Spring.....
33351	22156	" " Bracket with 453C.....
453C	22156	" " " Set Screw.....
11170	22156	" " Washer.....
7309	22153	" Foot Cap.....
220J	22156	" " Screw.....
7310	22153	" " Hinge Connection.....
7311	22156	" " " Hinge Pin...
106D	22156	" " " " Screw.
62527	22156	" " " Fin.....
20921	22153	" " Plate (left).....
20964	22153	" " " (right).....
20923	22153	" " Shank with 7311.....
20924	22153	" " Bracket.....
20965	22153	Presser Foot (hinged compensating) complete, Nos. 106D, 220J, 7309, 7310, 20921, 20924, 20964 and two each 20923 and 62527.....
190J	5247	Presser Foot Screw.....
688J	22156	Pressure Regulating Thumb Screw.....
20966	22158	Slack Thread Controller.....
228J	22156	" " " Set Screw.....
2102	22156	Tension Disc.....
1560C	22156	" Regulating Thumb Nut.....
1110C	22156	" Screw Stud.....
20972	-----	" " " 1110C with 1560C.....
10148	22156	" Spring.....

## PARTS FOR MACHINE 55-20

No.	Plate	Name
57076	22156	Tension Thread Guide (double).....
20967	22156	Thread Eyelet.....
440C	22156	" " Set Screw.....
20968	22154	Throat Plate with 20969 and two 337J, for 20945.....
Note: No. 20968 Throat Plate is sent with this Machine unless another Throat Plate is specified on order.		
20975	22154	Throat Plate with 20969 and two 337J, for 1/4 in. stitch, for 20974.....
20969	22154	Throat Plate Needle Guard.....
337J	22154	" " " " Screw.....
691F	22154	" " " Screw.....
44212	22160	Drip Pan with four 1 in. wire nails.....
*15404	-----	Trade Mark.....
15405	-----	" " Rivet.....

SINGER Needles should be used  
in SINGER Machines.  
These Needles and their Containers  
are marked with the  
Company's Trade Mark "SIMANCO.\*\*\*" 1

Needles in Containers marked  
"FOR SINGER MACHINES"  
are NOT **SINGER** made needles. 2

## ACCESSORIES

No.	Plate	Name
12361	22158	Machine Hinge Connection.....
44139	22158	" " Plate.....
44140	-----	Machine Hinge complete, Nos. 12361, 44139 and merlized wood screw 1 1/4 in. No.14
12405	22158	Machine Rest (felt).....
28084	22158	" " Pin.....
120344	22157	Oiler (copper plated) with 120345.....
120345	22157	" Spout, 4 1/2 in. long.....
28026	22157	Screw Driver (large).....
28485	22157	" " (small).....
120341	22157	Tweezers (curved).....
8909	22157	Wrench for 1513 and 1518.....
4822	22157	" " 1521.....
8908	22157	" " 1519 and 1520.....

## FINGER GUARD

No.	Plate	Name
36818	22153	Finger Guard.....
36819	22153	" " Friction Washer.....
50316J	22153	" " Hinge Screw.....
36820	22153	" " Holder with 196J.....
196J	22153	" " Clamping Screw.....
36821	22153	Finger Guard complete, Nos. 36818 to 36820 and 50316J.....

## FOOT LIFTER PARTS

No.	Plate	Name
5596	22155	Bell Crank.....
56848	-----	" " 5596 with 5599 and 5601.....
5599	22155	" " Bracket.....
178E	22158	" " Screw.....
5601	22158	" " Hinge Pin.....
5735	22155	" " Spring.....
5598	-----	Bell Crank complete, Nos. 5735 and 56848..
5670	-----	Chain, length 26 in. to 35 in., with 56844 and 56865.....

Note: When ordering No. 5670, state length required

## FOOT LIFTER PARTS

No.	Plate	Name
4879	22159	Chain Connecting Link.....
56864	22159	" Hook (large).....
56865	22159	" " (small).....
12237	22155	Lifting Lever with 448C.....
52028	22155	" " Connecting Rod.....
12416	22158	" " " " Joint.....
76D	22158	" " " " " Hinge Screw.....
1521E	22158	Lifting Lever Connecting Rod Lock Nut....
802D	22158	" " Hinge Screw.....
12241	22158	" " Link.....
766D	22156	" " Hinge Screw.....
12240	22158	" " Pin.....
448C	5247	" " Set Screw.....
2763	22161	Rock Shaft.....
12242	22161	" " Hanger with two wood screws 1 in. No. 10.....
6337	22161	Rock Shaft Lifting Bracket with two 356C..
12243	22161	" " " " Hook.....
7125	22161	" " " " Hook.....
356C	22158	" " " " Set Screw.
356C	22158	" " " " Set Screw.....
2770	22161	" " Stop Dog with 356C.....
356C	22158	" " " " Set Screw.....
4880	22161	Rock Shaft complete, Nos. 2763,2770,7125, 12243 and two each 6337 and 12242.....
4881	22160	Treadle.....
4882	22159	" Shaft.....
4883	22159	" Spring.....
4884	22160	" Stand.....
4885	22160	Treadle complete, Nos. 4879,4881 to 4884 and two wood screws 1 in. No. 16.....
52319	-----	Foot Lifter complete, Nos. 76D,766D,802D, 1521E,4880,4885,5598,5670,12237,12240, 12241,12416,52028 and two 178E.....

## KNEE LIFTER PARTS

No.	Plate	Name
5596	22155	Bell Crank.....
56848	-----	" " 5596 with 5599 and 5601.....
5599	22155	" " Bracket.....
178E	22158	" " Screw.....
5601	22158	" " Hinge Pin.....
5735	22155	" " Spring.....

## KNEE LIFTER PARTS

No.	Plate	Name
5598	-----	Bell Crank complete, Nos. 5735 and 56848..
12237	22155	Lifting Lever with 448C.....
52028	22155	" " Connecting Rod.....
12416	22158	" " " " Joint.....
76D	22156	" " " " " Hinge Screw.....
1521E	22158	Lifting Lever Connecting Rod Lock Nut.....
802D	22158	" " Hinge Screw.....
12241	22158	" " Link.....
766D	22156	" " Hinge Screw.....
12240	22158	" " Pin.....
448C	5247	" " Set Screw.....
2763	22161	Rock Shaft.....
7539	22161	" " Hanger with two wood screws 1 in. No. 10.....
2765	22161	Rock Shaft Knee Arm.....
2766	22161	" " " " Hub with 356C.....
356C	22158	" " " " Set Screw.....
2768	-----	" " " " 2765 with 2766 and 2767.....
2767	22161	Rock Shaft Knee Plate with 356C.....
356C	22158	" " " " Set Screw.....
6337	22161	" " Lifting Bracket with two 356C..
2778	22161	" " " " Hook.....
356C	22158	" " " " Set Screw.....
356C	22158	" " " " Set Screw.....
2770	22161	" " Stop Dog with 356C.....
356C	22158	" " " " Set Screw.....
12250	22161	Rock Shaft complete, Nos. 2763, 2768, 2778, 6337 and two each 2770 and 7539.....
52320	-----	Knee Lifter complete (power table) Nos. 76D, 766D, 802D, 1521E, 5598, 12237, 12240, 12241, 12250, 12416, 52028 and two 178E...

## THREAD UNWINDER

## FOR TWO SPOOLS

No.	Plate	Name
225257	20335	Spool Rest with 201018C.....
150203	20335	" " Cushion (felt).....
225388	20335	" " Rod.....
200383C	22158	" " Set Screw.....
201018C	22158	" " Set Screw.....
202490	20335	" Stand with 200383C.....

## THREAD UNWINDER

No.	Plate	Name
225391	20335	Thread Guide.....
201696J	22156	" " Lock Nut.....
225326	20335	" " Position Cup.....
225324	20335	" " Rod with 208E and 225322.....
208E	5247	" " " Screw.....
225322	22156	" " " Washer.....
225258	20335	Thread Unwinder complete, Nos. 201696J, 202490, 225257, 225324, 225326, 225388, two each 150203, 225391 and three wood screws 7/8 in. No. 12.....
27739	22159	Thread Cone (wood) for large cones.....
225390	22159	" " Holder, for inverted cones....

Note: Nos. 27739 and 225390 are used with, but not  
included in 225258.

SINGER Needles should be used  
in SINGER Machines.  
These Needles and their Containers  
are marked with the  
Company's Trade Mark "SIMANCO. \*\*" 1

Needles in Containers marked  
"FOR SINGER MACHINES"  
are NOT **SINGER** made needles. 2



## NUMERICAL LIST OF PARTS

No.	Plate	Name
76D	22156	Lifting Lever Connecting Rod Joint Hinge Screw for 52319 and 52320.....
108D	22156	Presser Foot Hinge Connection Hinge Screw for 20965.....
121E	22152	Looper Driving Shaft Gear Case Screw for 127007.....
144D	5247	Arm Shaft (horizontal) Screw.....
145E	5249	Feed Connecting Rod Cap Screw for 20981...
157J	5249	" Lifting Rock Shaft Crank Clamping Screw for 20949.....
158E	5247	Arm Top Cover Screw.....
176J	5249	Guide Adjusting Screw.....
178E	22158	Bell Crank Bracket Screw for 52319 and 52320.....
184E	5249	Guide Screw Stud.....
190J	5247	Face Plate Screw.....
190J	5247	Presser Foot Screw.....
196J	22153	Finger Guard Holder Clamping Screw for 36820.....
207E	22152	Needle Bar Connecting Stud Clamping Screw for 24041.....
208J	5247	Face Plate Thread Nipper Disc Cover Screw for 20939.....
208E	5247	Thread Unwinder Thread Guide Rod Screw for 225324.....
210J	5247	Balance Wheel Oil Cover Screw.....
211E	5247	Feed Dog Screw.....
219J	5247	Arm Side Cap Screw.....
220J	22156	Presser Foot Cap Screw for 20965.....
226J	22152	Feed Lifting Rock Shaft Crank Slide Block Cap Screw for 20978.....
228J	22156	Slack Thread Controller Set Screw.....
313C	5249	Feed Bar Screw Center for 56813.....
337J	22154	Throat Plate Needle Guard Screw for 20968 and 20975.....
356C	22158	Rock Shaft Lifting Bracket Hook Set Screw.
356C	22158	" " " " Set Screw for 6337.....
356C	22158	Rock Shaft Stop Dog Set Screw for 2770....
356C	22158	" " Knee Arm Hub Set Screw for 2766
356C	22158	" " Plate Set Screw for 2767..
356C	22158	" " Lifting Bracket Hook Set Screw.
375C	5249	Feed Lifting Forked Connection Hinge Screw
432C	5247	Arm Shaft (upright) Bushing (lower) Set Screw.....

## NUMERICAL LIST OF PARTS

No.	Plate	Name
435C	5247	Arm Shaft (horizontal) Flanged Bushing (front) Set Screw.....
440C	22156	Thread Eyelet Set Screw.....
448C	5247	Arm Shaft (horizontal) Flanged Bushing (back) Set Screw.....
448C	5247	Balance Wheel Set Screw for 52005.....
448C	5247	Feed Cam and Feed Lifting Eccentric Set Screw for 20942.....
448C	5247	Lifting Lever Pin Set Screw for 12237.....
453C	22156	Presser Bar Spring Bracket Set Screw for 33351.....
688J	22156	Pressure Regulating Thumb Screw.....
689C	22152	Presser Bar Lifter Screw.....
691F	22154	Throat Plate Screw.....
725J	5247	Bed Slide Spring Screw for 20937.....
748E	5245	Arm Screw (back).....
766D	22156	Lifting Lever Link Hinge Screw for 52319 and 52320.....
790C	5249	Feed Rock Shaft Regulator Crank Position Screw for 20951.....
794E	22152	Needle Bar Connecting Link Adjusting Screw for 24040.....
802D	22158	Lifting Lever Hinge Screw for 52319 and 52320.....
853C	22152	Needle Bar Thread Retainer Bracket Set Screw for 20962.....
854E	5245	Arm Screw (front).....
857H	22152	Needle Set Screw for 20957.....
859C	22152	" Bar Crank Set Screw for 20960.....
896C	5249	Feed Connecting Rod Hinge Screw Clamping Screw for 20981.....
940D	22152	Guide Holder Hinge Screw for 120428.....
1036C	5247	Arm Shaft (horizontal) Gear Set Screw for 59703.....
1057E	5249	Feed Lifting Forked Connection Cap Screw for 20946.....
1065C	22152	Needle Bar Crank Position Screw for 20960.....
1110C	22156	Tension Screw Stud for 20972.....
1120C	5249	Looper Set Screw for 20955.....
1133E	22152	Needle Bar Bushing (lower) Set Screw.....
1133F	22152	" " " (upper) Set Screw.....
1143C	5249	Looper Driving Shaft Bushing Set Screw....
1147C	5249	Feed Rock Shaft Regulator Crank Set Screw for 20951.....
1148C	22152	Looper Shaft Bushing Set Screw.....
1149C	5247	Arm Shaft (upright) Bushing (upper) Set Screw.....

## NUMERICAL LIST OF PARTS

No.	Plate	Name
1253C	5247	Arm Shaft (upright) Gear (upper) Set Screw for 59708.....
1258C	22152	Needle Bar Connecting Link Hinge Stud Set Screw for 20960.....
1259C	5247	Arm Shaft (upright) Gear (lower) Set Screw for 127073.....
1259C	5247	Looper Driving Shaft Gear Set Screw for 127073.....
1449C	22152	Needle Bar Thread Retainer Screw for 20961
1513J	5249	Feed Lifting Rock Shaft Screw Center Nut for 52097.....
1513J	5249	Feed Rock Shaft Screw Center Nut for 52097
1518E	5249	" Lifting Forked Connection Hinge Screw Nut.....
1519J	5249	Feed Bar Screw Center Nut for 56813.....
1519J	5249	" Lifting Rock Shaft Crank Slide Block Screw Stud Nut for 20950.....
1520E	22156	Presser Bar Lifter Screw Nut.....
1521E	22158	Lifting Lever Connecting Rod Lock Nut for 52319 and 52320.....
1560C	22156	Tension Regulating Thumb Nut for 20972....
1714E	5249	Feed Connecting Rod Hinge Screw Nut for 20983.....
2102	22156	Tension Disc.....
2763	22161	Rock Shaft for 4880 and 12250.....
2765	22161	" " Knee Arm for 2768.....
2766	22161	" " " " Hub with 356C, for 2768.....
2767	22161	Rock Shaft Knee Plate with 356C, for 2768.
2768	-----	" " " Arm 2765 with 2766 and 2767, for 12250.....
2770	22161	Rock Shaft Stop Dog with 356C, for 4880 and 12250.....
2778	22161	Rock Shaft Lifting Bracket Hook for 12250.
2827	5247	Face Plate Thread Guard with 8505, for 20938.....
4822	22157	Wrench for 1521 (Accessories).....
4879	22159	Chain Connecting Link for 4885.....
4880	22161	Rock Shaft complete, Nos. 2763,2770,7125, 12243 and two each 6337 and 12242, for 52319.....
4881	22160	Treadle for 4885.....
4882	22159	" Shaft for 4885.....
4883	22159	" Spring for 4885.....
4884	22160	" Stand for 4885.....
4885	22160	Treadle complete, Nos. 4879,4881 to 4884 and two wood screws 1 in. No. 16, for 52319.....

## NUMERICAL LIST OF PARTS

No.	Plate	Name
5596	22155	Bell Crank for 56848.....
5598	-----	Bell Crank complete, Nos. 5735 and 56848, for 52319 and 52320.....
5599	22155	Bell Crank Bracket for 56848.....
5601	22158	" " Hinge Pin for 56848.....
5670	-----	Chain, length 26 in. to 35 in., with 56864 and 56865, for 52319.....
5735	22155	Bell Crank Spring for 5598.....
5947	5248	Bed Slide Spring for 20937.....
5990	22152	Presser Bar Lifter.....
6337	22161	Rock Shaft Lifting Bracket with two 356C, for 4880 and 12250.....
7071	5249	Guide Thumb Screw Washer for 120428.....
7071	5249	" Adjusting Screw Washer.....
7125	22161	Rock Shaft Lifting Bracket Hook for 4880..
7309	22153	Presser Foot Cap for 20965.....
7310	22153	" " Hinge Connection for 20965...
7311	22156	" " " " Hinge Pin for 20923.....
7539	22161	Rock Shaft Hanger with two wood screws 1 in. No. 10, for 12250.....
8505	5247	Face Plate Thread Guard Rivet for 2827....
8582	5245	Arm Dowel Pin.....
8908	22157	Wrench for 1519 and 1520 (Accessories)....
8909	22157	" " 1513 and 1518 (Accessories)....
9543	5247	Face Plate Thread Nipper Disc for 20939...
9544	5247	" " " " " " Cover for 20939.....
9545	5247	Face Plate Thread Nipper Disc Spring for 20939.....
9611	22152	Needle Bar Thread Tube for 20957.....
10148	22156	Tension Spring.....
11167	22155	Presser Bar Spring.....
11170	22156	" " " Washer.....
12193	5246	Arm Side Cover.....
12237	22155	Lifting Lever with 448C, for 52319 and 52320.....
12240	22158	Lifting Lever Pin for 52319 and 52320.....
12241	22158	" " Link for 52319 and 52320....
12242	22161	Rock Shaft Hanger with two wood screws 1 in. No. 10, for 4880.....
12243	22161	Rock Shaft Lifting Bracket Hook for 4880..
12250	22161	Rock Shaft complete, Nos. 2763,2768,2778, 6337 and two each 2770 and 7539, for 52320.....
12361	22158	Machine Hinge Connection for 44140 (Ac- cessories).....
12403	5247	Arm Spool Pin and Thread Eyelet for 20933.

## NUMERICAL LIST OF PARTS

No.	Plate	Name
12405	22158	Machine Rest (felt) (Accessories).....
12416	22158	Lifting Lever Connecting Rod Joint for 52319 and 52320.....
12424	5249	Feed Lifting Rock Shaft Crank Slide Block Cap Screw Washer for 20978.....
12480	5246	Arm Side Cap.....
15170	5249	Feed Lifting Rock Shaft Crank Slide Block for 20978.....
*15404	-----	Trade Mark for 20929.....
15405	-----	" " Rivet for 20929.....
20921	22153	Presser Foot Plate (left) for 20965.....
20923	22153	" " Shank with 7311, for 20965...
20924	22153	" " Bracket for 20965.....
*20929	-----	Arm with 15404 and two 15405.....
20930	22160	" Shaft (horizontal) for 20979.....
20931	5246	" " (upright).....
20932	5247	" " Bushing (upper).....
20933	5246	" Top Cover 20973 with 12403 and two 20934.....
20934	5245	Arm Top Cover Oil Tube with 56006, for oiling 20981 and 20946, for 20933.....
*20935	-----	Bed.....
20936	-----	" Slide for 20937.....
20937	5248	" " 20936 with 5947 and two 725J....
20938	5248	Face Plate with 20940 and two 2827, for 20939.....
20939	-----	Face Plate complete, Nos. 208J, 9544, 9545, 20938 and two 9543.....
20940	5247	Face Plate Thread Eyelet for 20938.....
20941	22151	Feed Bar.....
20942	5248	" Cam and Feed Lifting Eccentric with two 448C, for 20980.....
20945	22154	Feed Dog, 17 teeth (12 teeth to the inch) for 20968.....
20946	5248	Feed Lifting Forked Connection with 20947 and two 1057E, for 20980.....
20947	-----	Feed Lifting Forked Connection Cap for 20946.....
20948	-----	Feed Lifting Rock Shaft complete, Nos. 20950 and 52384.....
20949	5248	Feed Lifting Rock Shaft Crank with 157J, for 20950.....
20950	-----	Feed Lifting Rock Shaft Crank complete, Nos. 1519J,20949 and 20978, for 20948..
20951	5248	Feed Rock Shaft Regulator Crank with 790C and two 1147C, for 20970.....
20952	5249	Feed Rock Shaft Regulator Crank Slide Block for 20983.....

## NUMERICAL LIST OF PARTS

No.	Plate	Name
20953	5249	Looper.....
20954	5249	" Driving Shaft.....
20955	22155	" Shaft with 1120C and 20956.....
*20956	5249	" Collar for 20955.....
20957	22155	Needle Bar (hollow) with 857H and 9611....
20958	22152	" " Bushing (upper).....
20959	22152	" " Connecting Link Hinge Stud for 20971.....
20960	22159	Needle Bar Crank with 858C,1065C and 1258C for 20979.....
20961	-----	Needle Bar Thread Retainer complete, Nos. 1449C,20962,54716 and 124794.....
20962	22152	Needle Bar Thread Retainer Bracket with 853C and two 42639, for 20961.....
20963	22155	Presser Bar.....
20964	22153	" Foot Plate (right) for 20965.....
20965	22153	Presser Foot (hinged compensating) com- plete, Nos. 106D,220J,7309,7310,20921, 20924,20964 and two each 20923 and 62527.....
20966	22158	Slack Thread Controller.....
20967	22156	Thread Eyelet.....
20968	22154	Throat Plate with 20969 and two 337J, for 20945.....
20969	22154	Throat Plate Needle Guard for 20968 and 20975.....
20970	-----	Feed Rock Shaft complete, Nos. 20951 and 52386.....
20971	-----	Needle Bar Connecting Link 24040 with 20959 and 24041.....
20972	-----	Tension Screw Stud 1110C with 1560C.....
20973	-----	Arm Top Cover for 20933.....
20974	22154	Feed Dog, 17 teeth (12 teeth to the inch) for 1/4 in. stitch for 20975, for Bast- ing Coat Lapels.....
20975	22154	Throat Plate with 20969 and two 337J, for 1/4 in. stitch, for 20974.....
20976	5249	Guide Leveling Plate.....
20978	-----	Feed Lifting Rock Shaft Crank Slide Block complete, Nos. 226J,12424,15170 and 51372C, for 20950.....
20979	-----	Arm Shaft (horizontal) 20930 with 20960 and 20980.....
20980	-----	Feed Lifting Forked Connection 20946 with 20942 and 20983, for 20979.....
20981	5248	Feed Connecting Rod with 896C and two 145E for 20983.....
20983	-----	Feed Connecting Rod 20981 with 1714E,20952 42523 and 51335C, for 20980.....

## NUMERICAL LIST OF PARTS

No.	Plate	Name
24040	22159	Needle Bar Connecting Link with 794E, for 20971.....
24041	22152	Needle Bar Connecting Stud with 207E, for 20971.....
26026	22157	Screw Driver (large) (Accessories).....
26485	22157	" " (small) (Accessories).....
27739	22159	Thread Unwinder Thread Cone (wood) for large cones.....
28084	22158	Machine Rest Pin (Accessories).....
28971	22151	Guide for 120428.....
28972	22151	" Holder for 120428.....
33351	22156	Presser Bar Spring Bracket with 453C.....
35610	5249	Guide Holder Friction Washer for 120428...
36818	22153	Finger Guard for 36821.....
36819	22153	" " Friction Washer for 36821....
36820	22153	" " Holder with 196J, for 36821..
36821	22153	Finger Guard complete, Nos. 36818 to 36820 and 50316J.....
42523	5247	Feed Connecting Rod Hinge Screw Nut Washer for 20983.....
42639	22152	Needle Bar Thread Retainer Position Pin for 20962.....
44139	22158	Machine Hinge Plate for 44140 (Accessories)
44140	-----	Machine Hinge complete, Nos. 12361, 44139 and merlized wood screw 1 1/4 in. No.14 (Accessories).....
44212	22160	Drip Pan with four 1 in. wire nails.....
50150C	22152	Looper Shaft Coupling Set Screw for 124765
50191C	5249	Feed Lifting Rock Shaft Screw Center for 52097.....
50191C	5249	Feed Rock Shaft Screw Center for 52097....
50234E	22152	Looper Driving Shaft Gear Case Plug Screw for 127007.....
50316J	22153	Finger Guard Hinge Screw for 36821.....
51224D	5247	Arm Side Cover Thumb Screw.....
51224D	5247	Guide Thumb Screw for 120428.....
51335C	5249	Feed Connecting Rod Hinge Screw for 20983.
51372C	5249	" Lifting Rock Shaft Crank Slide Block Screw Stud for 20978.....
52005	5246	Balance Wheel (power) light rim, 2 3/16 in. pulley, with two 448C.....
52028	22155	Lifting Lever Connecting Rod for 52319 and 52320.....
52045	5245	Arm Oil Tube Packing (wick) for 52084.....
52045	5245	Looper Driving Shaft Bushing Packing (wick) for 127043.....
52045	5245	Looper Shaft Bushing Packing (wick) for 127044.....
52083	5246	Balance Wheel Oil Cover.....

## NUMERICAL LIST OF PARTS

No.	Plate	Name
52084	5245	Arm Oil Tube with 52045, for oiling 24040.
52097	-----	Feed Lifting Rock Shaft Screw Center 50191C with 1513J.....
52097	-----	Feed Rock Shaft Screw Center 50191C with 1513J.....
52148	5245	Arm Oil Tube for 52149.....
52149	-----	" " " 52148 with 52150, for oiling 59703.....
52150	5245	Arm Oil Tube Oil Pad (braided cotton) for 52149.....
52151	5246	Arm Shaft (horizontal) Flanged Bushing (back) for 52192.....
52192	-----	Arm Shaft (horizontal) Flanged Bushing (back) 52191 with 52193 and 52194.....
52193	5245	Arm Shaft (horizontal) Flanged Bushing (back) Oil Pad, inside (braided cotton) for 52192.....
52193	5245	Arm Shaft (horizontal) Flanged Bushing (front) Oil Pad, inside (braided cotton) for 52196.....
52194	5245	Arm Shaft (horizontal) Flanged Bushing (back) Oil Pad, outside (felt) for 52192.....
52195	5246	Arm Shaft (horizontal) Flanged Bushing (front) for 52196.....
52196	-----	Arm Shaft (horizontal) Flanged Bushing (front) 52195 with 52193 and 52198.....
52198	5245	Arm Shaft (horizontal) Flanged Bushing (front) Oil Pad, outside (felt) for 52196.....
52319	-----	Foot Lifter complete, Nos. 76D, 766D, 802D, 1521E, 4880, 4885, 5598, 5670, 12237, 12240, 12241, 12416, 52028 and two 178E.....
52320	-----	Knee Lifter complete (power table) 76D, 766D, 802D, 1521E, 5598, 12237, 12240, 12241, 12250, 12416, 52028 and two 178E.....
52384	22151	Feed Lifting Rock Shaft for 20948.....
52386	22151	" Rock Shaft for 20970.....
52492	5247	Arm Shaft (upright) Bushing (lower).....
54716	22156	Needle Bar Thread Retainer Spring for 20961.....
56006	5245	Arm Top Cover Oil Tube Packing (braided cotton) for 20934.....
56015	5245	Arm Oil Tube for oiling 20932 and 52492.....
56813	-----	Feed Bar Screw Center 313C with 1519J.....
56848	-----	Bell Crank 5596 with 5599 and 5601, for 5598.....
56864	22159	Chain Hook (large) for 5670.....

## NUMERICAL LIST OF PARTS

No.	Plate	Name
56865	22159	Chain Hook (small) for 5670.....
57076	22156	Tension Thread Guide (double).....
59703	5247	Arm Shaft (horizontal) Gear with two 1036C
59708	5247	" " (upright) Gear (upper) with two 1253C.....
62527	22156	Presser Foot Hinge Pin for 20965.....
68350	5245	Arm Oil Cup for oiling 52195.....
120341	22157	Tweezers (curved) (Accessories).....
120344	22157	Oiler (copper plated) with 120345 (Accessories).....
120345	22157	Oiler Spout 4 1/2 in. long, for 120344 (Accessories).....
120427	22151	Guide Holder Shank for 120428.....
120428	22151	Guide (adjustable hinged) complete, Nos. 940D, 7071, 28971, 28972, 35610, 51224D and 120427.....
124765	22151	Looper Shaft Coupling with four 50150C....
124794	22152	Needle Bar Thread Retainer for 20961.....
127004	22151	Looper Driving Shaft Bushing for 127043...
127005	22151	" Shaft Bushing for 127044.....
127007	22159	" Driving Shaft Gear Case (two pieces) with 121E and 50234E.....
127043	-----	Looper Driving Shaft Bushing 127004 with 52045.....
127044	-----	Looper Shaft Bushing 127005 with 52045....
127073	5247	Arm Shaft (upright) Gear (lower) with two 1259C.....
127073	5247	Looper Driving Shaft Gear with two 1259C..
130768	22152	Needle Bar Bushing (lower).....
150203	20335	Thread Unwinder Spool Rest Cushion (felt) for 225258.....
200383C	22158	Thread Unwinder Spool Rest Rod Set Screw for 202490.....
201018C	22158	Thread Unwinder Spool Rest Set Screw for 225257.....
201696J	22156	Thread Unwinder Thread Guide Lock Nut for 225258.....
202490	20335	Thread Unwinder Spool Stand with 200383C, for 225258.....
225257	20335	Thread Unwinder Spool Rest with 201018C, for 225258.....
225258	20335	Thread Unwinder complete, Nos. 201696J, 202490, 225257, 225324, 225326, 225388, two each 150203, 225391 and three wood screws 7/8 in. No. 12.....
225322	22156	Thread Unwinder Thread Guide Rod Washer for 225324.....
225324	20335	Thread Unwinder Thread Guide Rod with 208E and 225322, for 225258.....

## NUMERICAL LIST OF PARTS

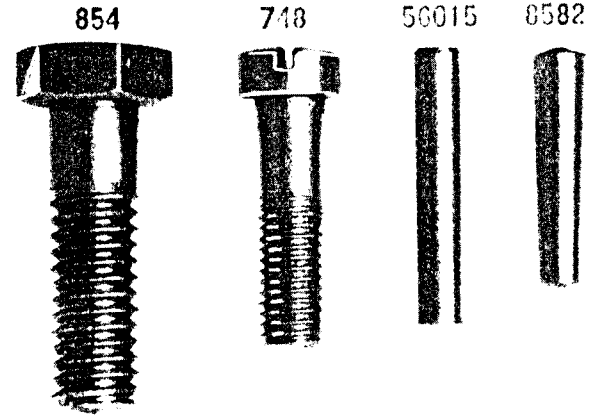
No.	Plate	Name
225326	20335	Thread Unwinder Thread Guide Position Cup for 225258.....
225368	20335	Thread Unwinder Spool Rest Rod for 225258.
225390	22159	" " Thread Cone Holder, for inverted cones.....
225391	20335	Thread Unwinder Thread Guide for 225258...

SINGER Needles should be used  
in SINGER Machines.  
These Needles and their Containers  
are marked with the  
Company's Trade Mark "SIMANCO.\*\*" 1

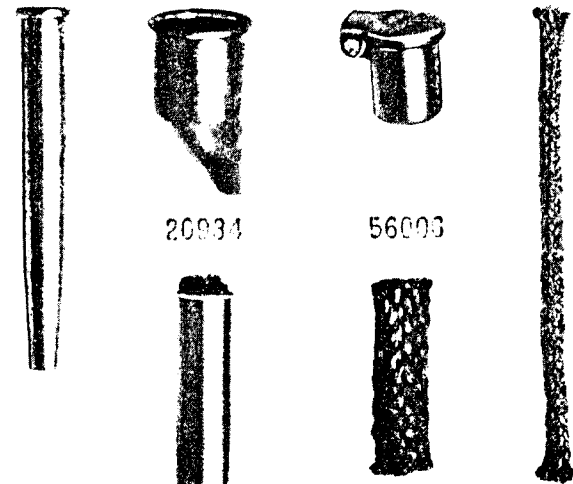
Needles in Containers marked  
"FOR SINGER MACHINES"  
are NOT **SINGER** made needles. 2

# ILLUSTRATIONS OF PARTS

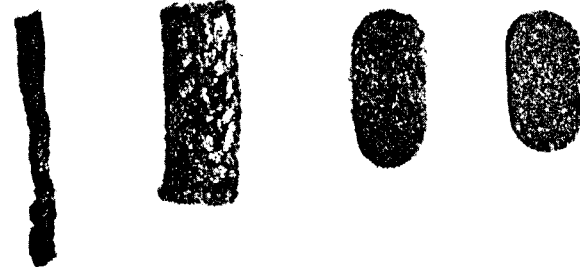
PLATE 5245 A — FULL SIZE



854 748 56015 8582



52094 52148 68350 52193



52015 52150 52198 52194

From the library of: Diamond Needle Corp

ILLUSTRATIONS

OF

SINGER NEEDLES  
 PARTS  
 These Needles  
 are marked with the  
 Company's Trade Mark

Needles to Carry  
 FOR SINGER  
 NOT SINGER

PLATE 5246—ONE-HALF SIZE

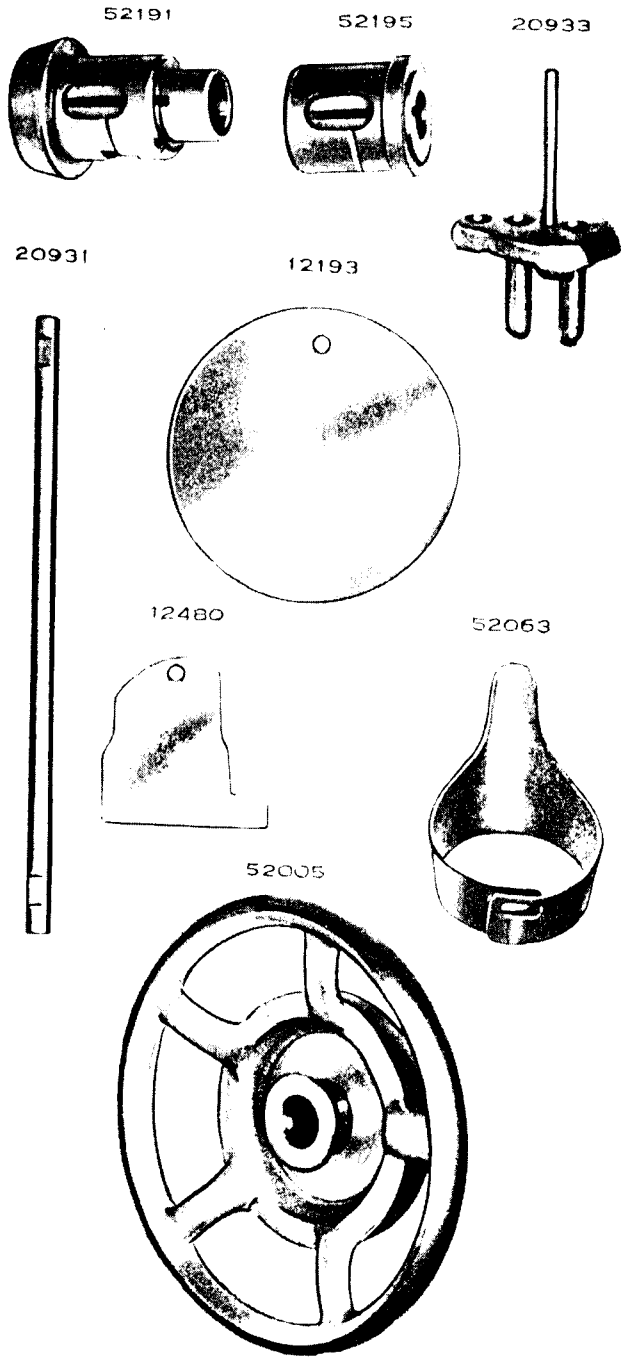


PLATE 5247—FULL SIZE

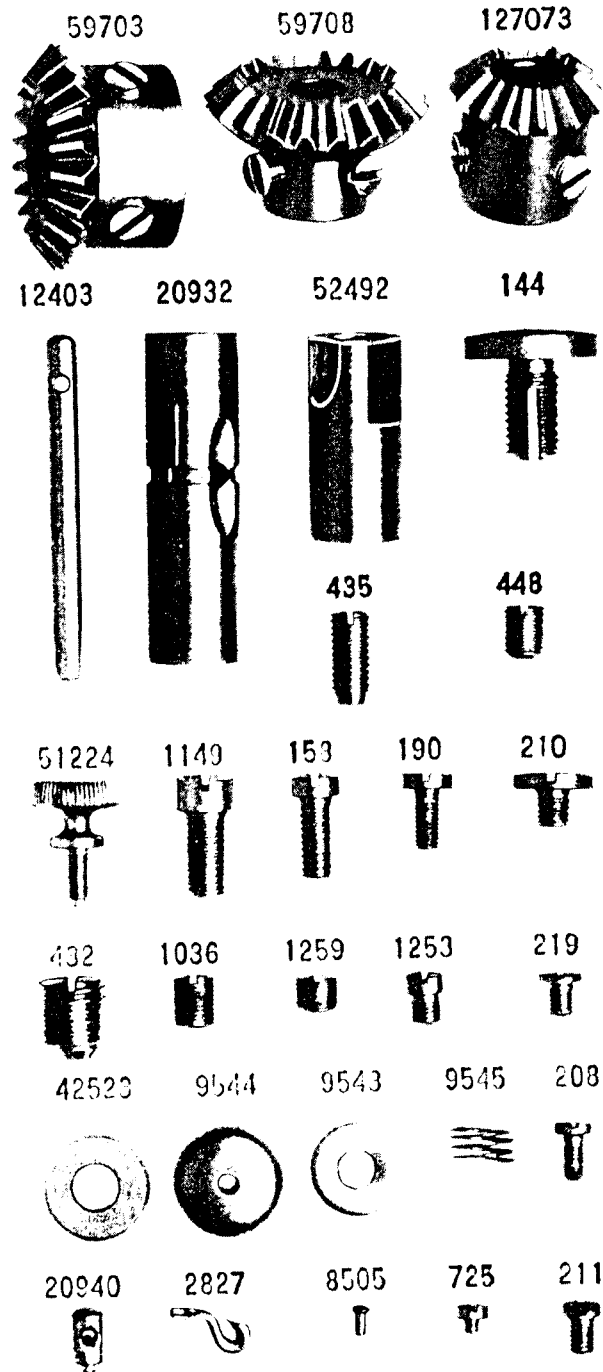




PLATE 5248—ONE-HALF SIZE

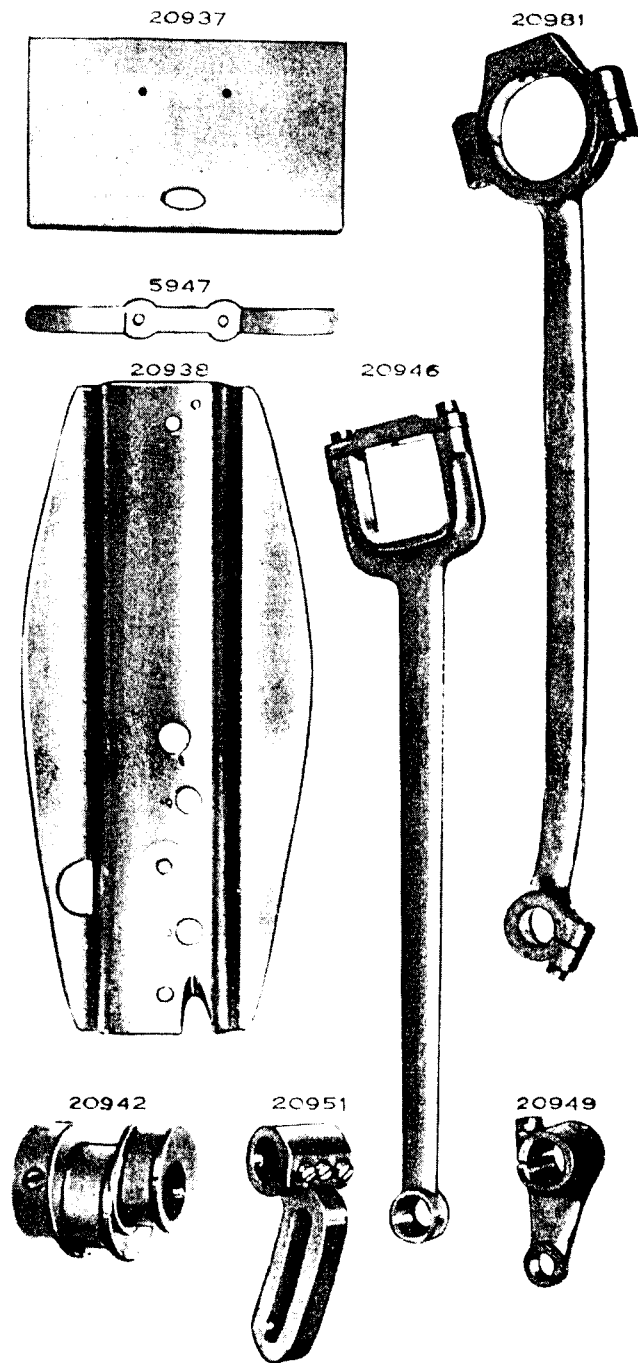
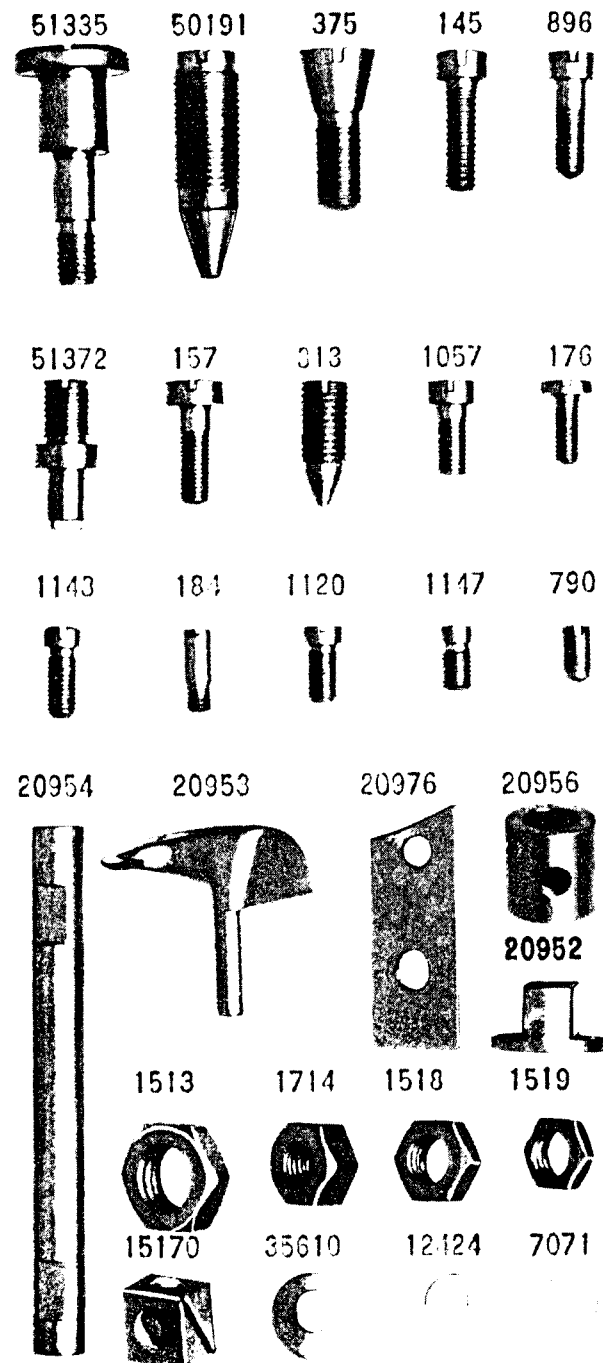


PLATE 5249—FULL SIZE



From the library of: Diamond Needle Corp

PLATE 22151 - ONE-HALF SIZE

52384 52386 124765 127004 127005

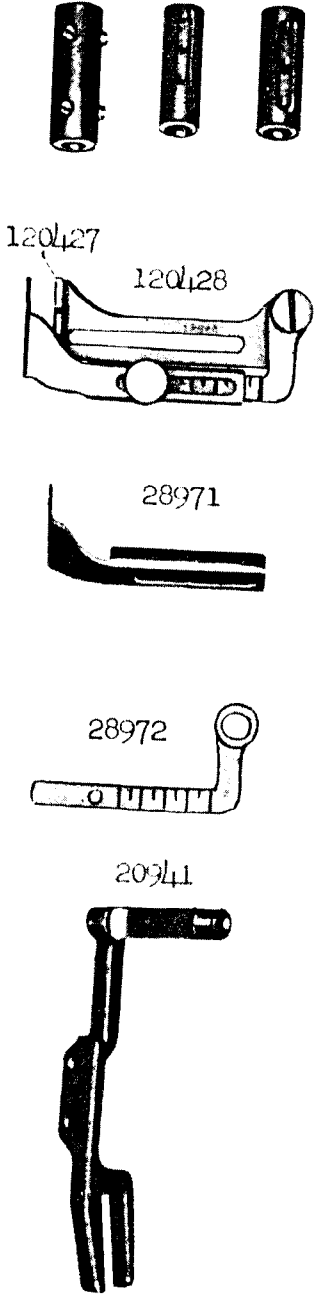
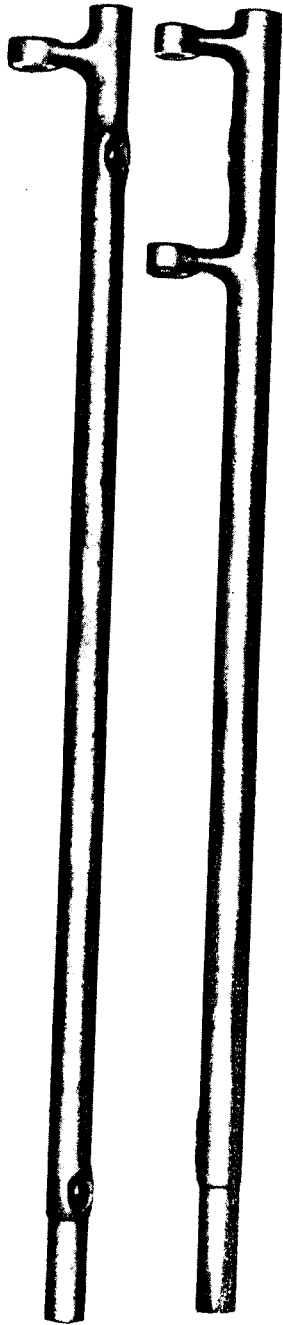
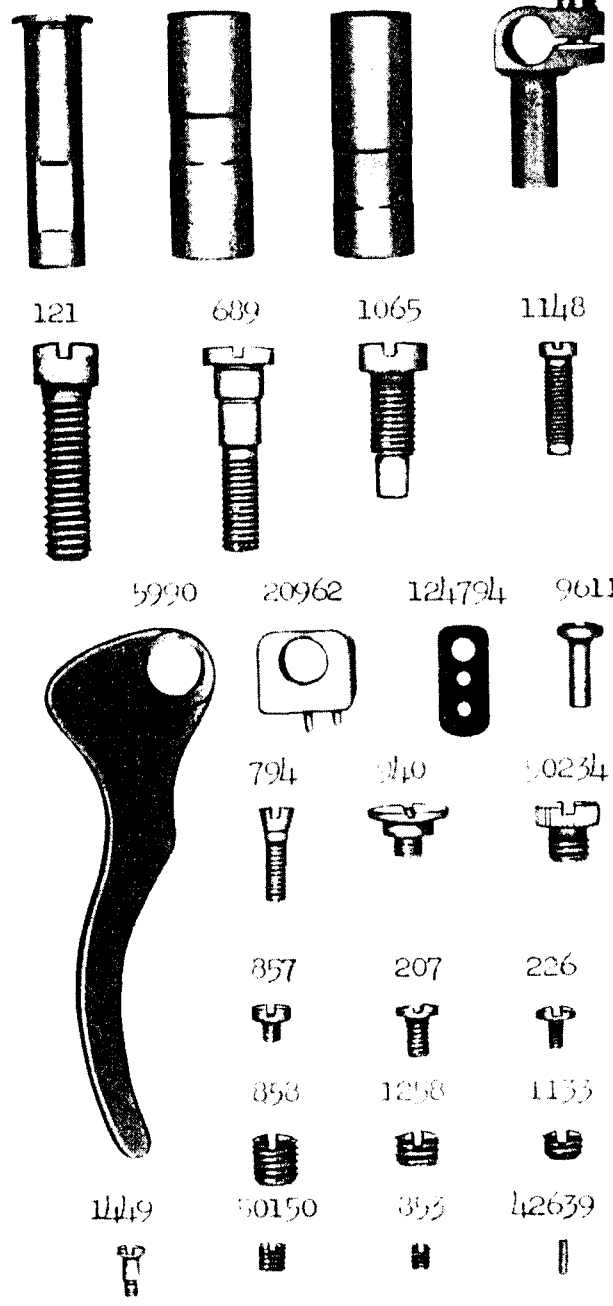


PLATE 22152 - FULL SIZE

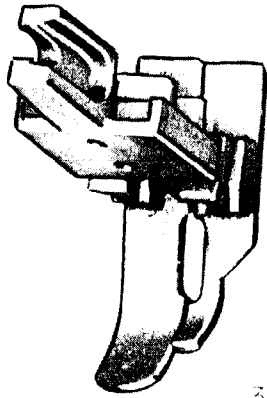
20959 20958 130768 24041



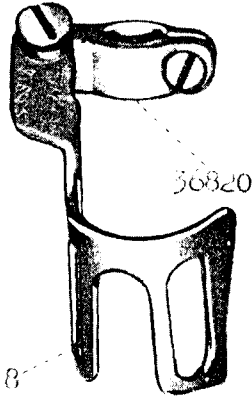
From the library of: Diamond Needle Corp

PLATE 22153 - FULL SIZE

20965



36821



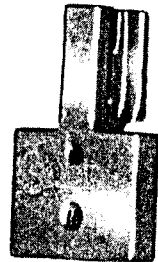
36820

36818

20921



20924



20924



20923



7310



7309



196



50316

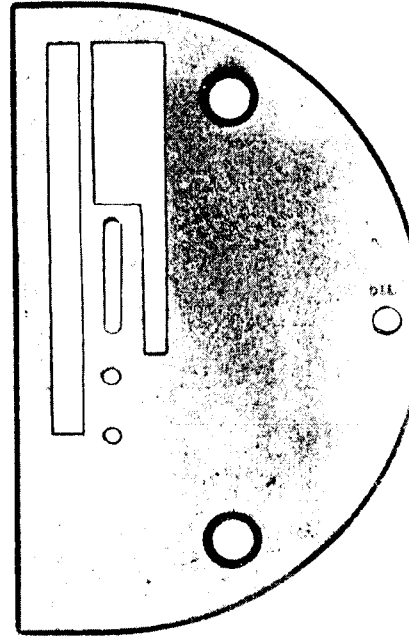


36819

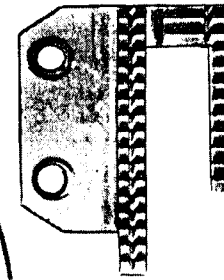


PLATE 22154 - FULL SIZE

20968



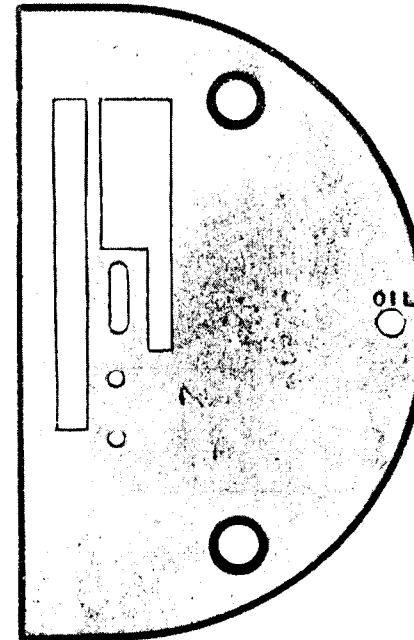
20945



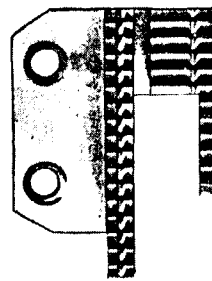
20969



20975



20974



601



337



PLATE 22155 - ONE-HALF SIZE

12237 20955 20957 20963 52028

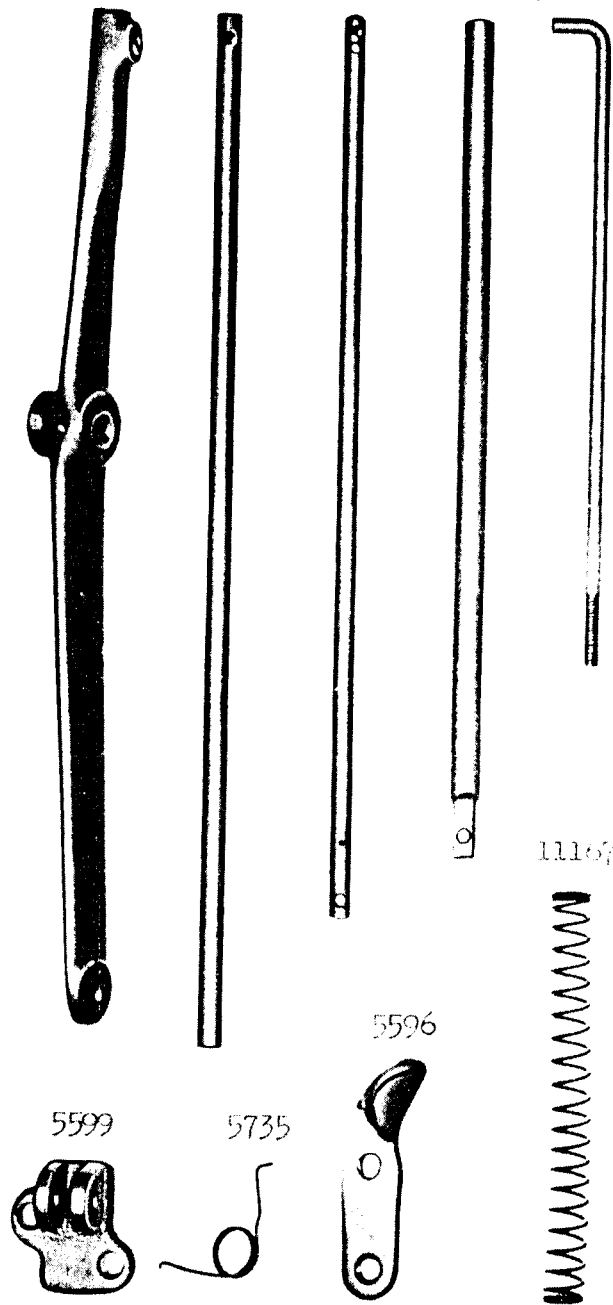
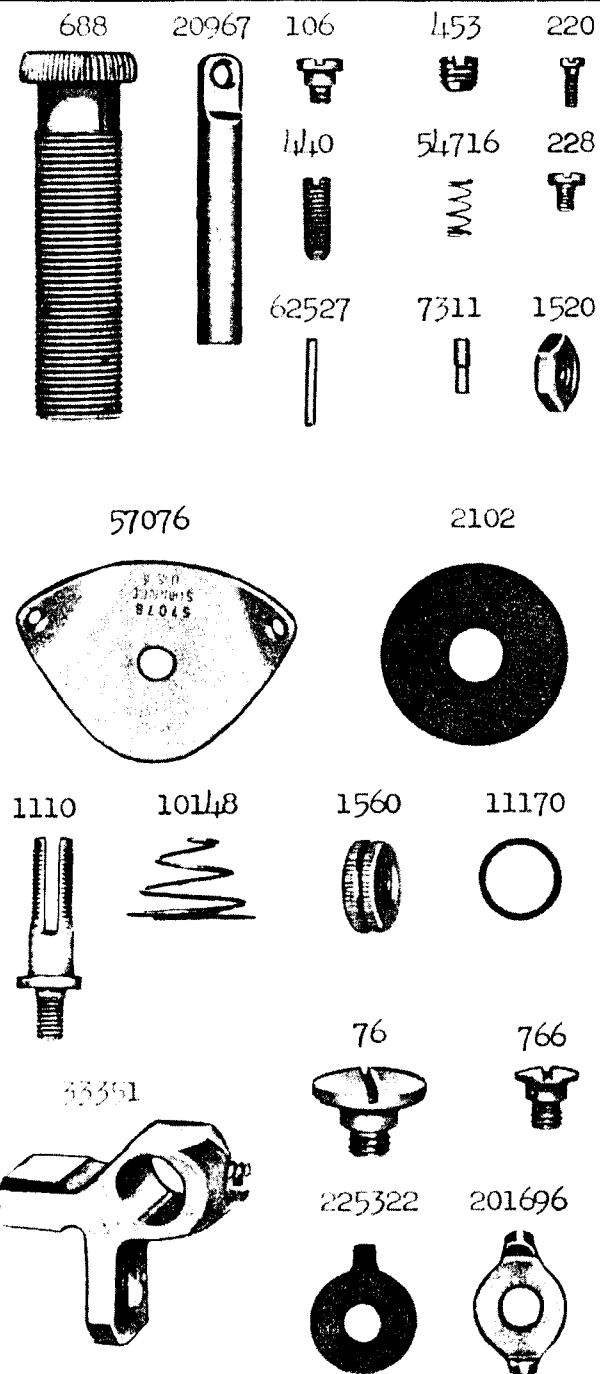


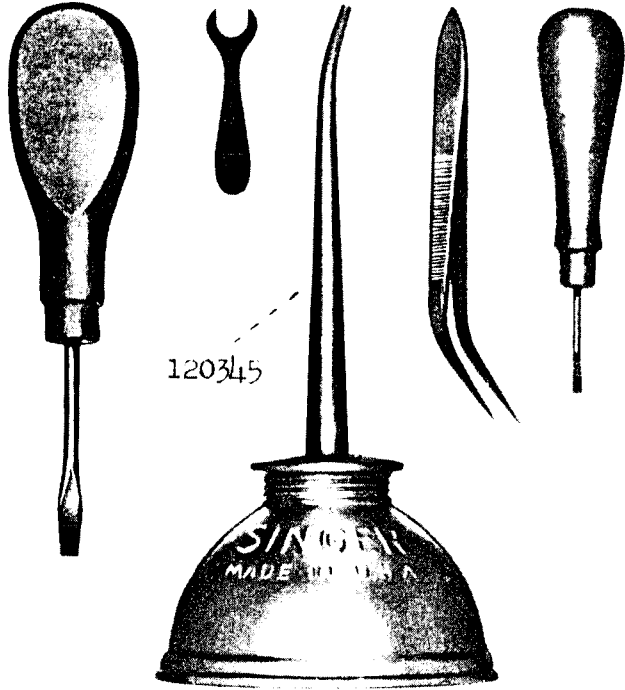
PLATE 22156 - FULL SIZE



From the library of: Diamond Needle Corp

PLATE 22157 - ONE-HALF SIZE

26026 4822 120344 120341 26485



120345

19221 8909 21654 8908

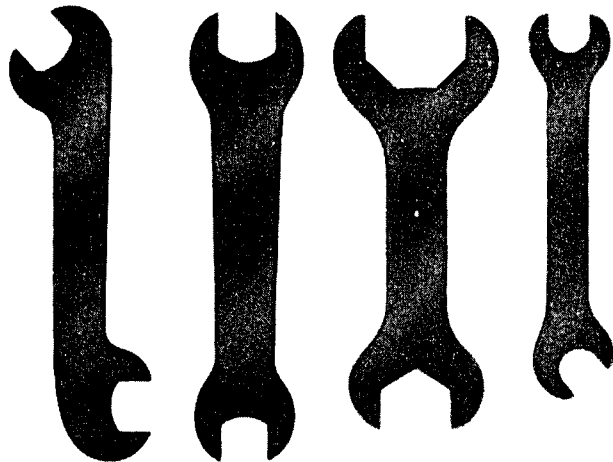
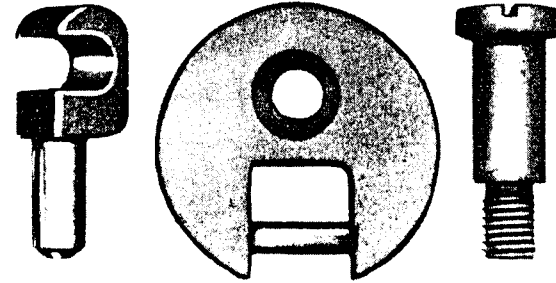
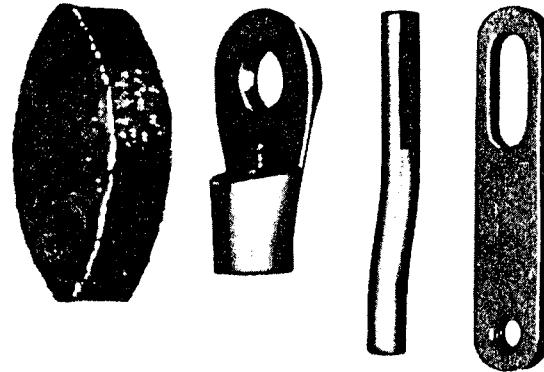


PLATE 22158 - FULL SIZE

12361 44139 802



12405 12416 12240 12241



356 178 201018 200383 1521



20966

28084 5601

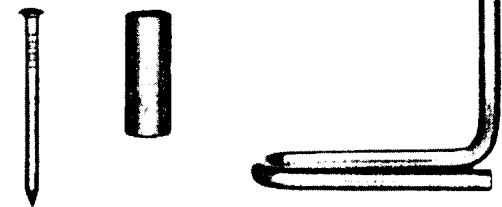


PLATE 22159 - ONE-HALF SIZE

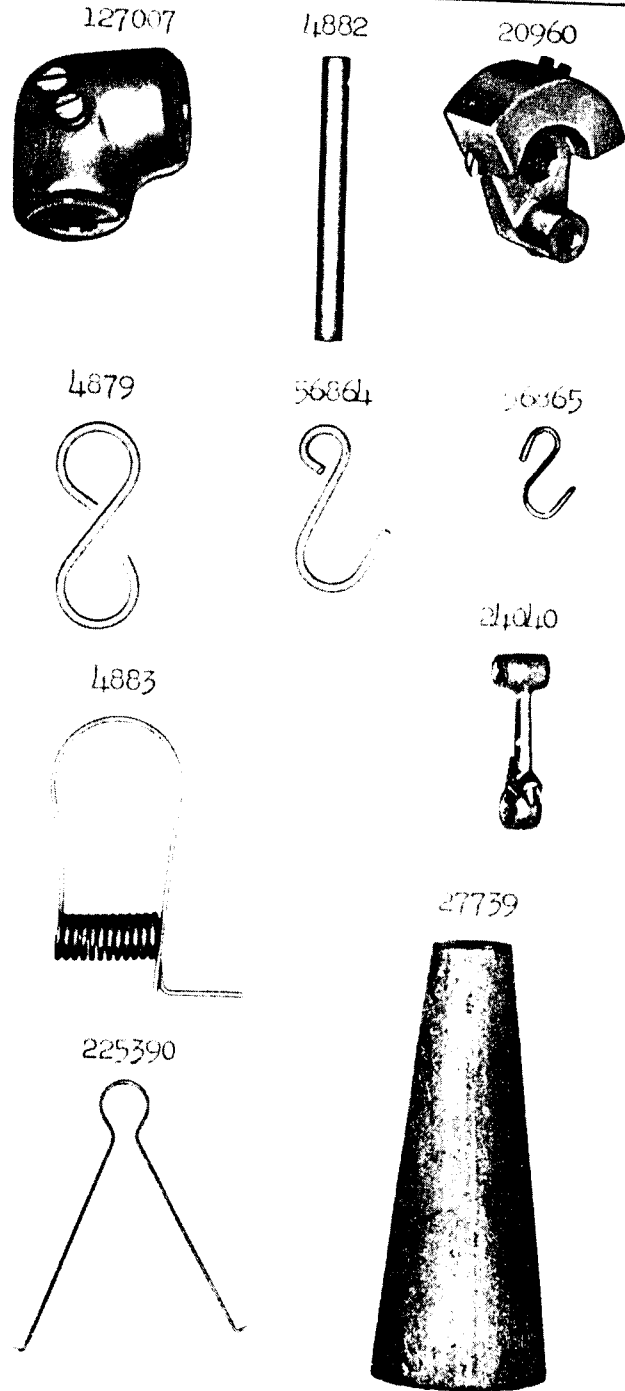
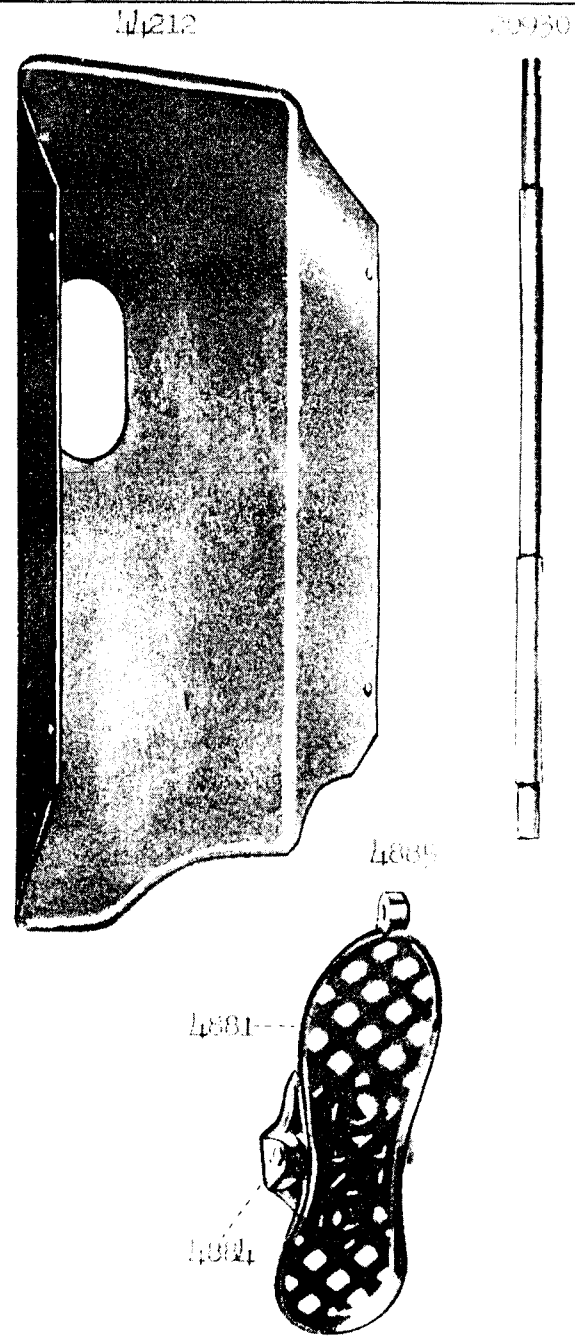


PLATE 22160 - ONE-FOURTH SIZE



From the library of: Diamond Needle Corp

PLATE 22161—ONE-FOURTH SIZE

